

PIPECON

Exhaust gas silencer
Reactive/Absorptive
COM 25

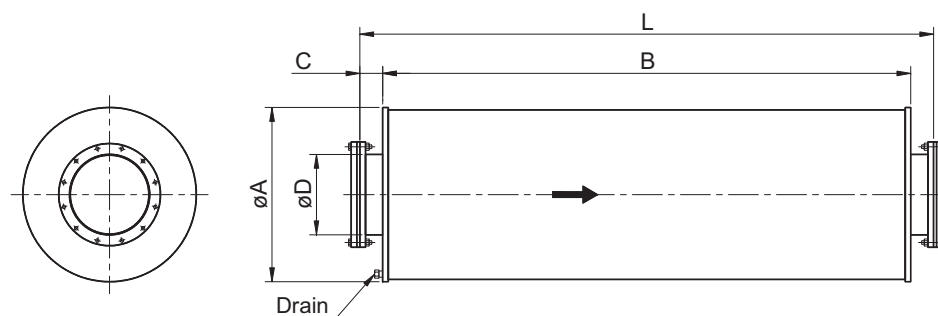

Stock no. 00220

Stock No.	ND	øD [mm]	øA [mm]	B [mm]	L [mm]	C [mm]	Approx. Weight [kg]	Flange dimensions					
								Outer dia [mm]	Inner dia [mm]	PCD [mm]	Bolts NxMxL	T [mm]	Flange standard
00220-01-0065	65	76,1	285	850	1010	80	28	185	77	145	4-M16x40	10	DIN 2576
00220-01-0080	80	88,9	335	950	1110	80	47	200	90	160	8-M16x40	10	DIN 2576
00220-01-0100	100	114,3	365	1050	1210	80	56	220	115,5	180	8-M16x40	10	DIN 2576
00220-01-0125	125	139,7	415	1150	1310	80	83	250	141,5	210	8-M16x40	10	DIN 2576
00220-01-0150	150	168,3	470	1400	1560	80	113	285	170,5	240	8-M20x45	10	DIN 2576
00220-01-0175	175	193,7	520	1500	1660	80	135	315	196	270	8-M20x45	10	DIN 2576
00220-01-0200	200	219,1	620	1650	1850	100	151	340	221,5	295	8-M20x45	10	DIN 2576
00220-01-0250	250	273,0	670	2010	2210	100	201	375	276	335	12-M16x50	16	DIN 86044
00220-01-0300	300	323,9	770	2200	2400	100	318	440	327	395	12-M20x60	16	DIN 86044

Description:

Silencer is delivered with flanges, mating flanges, gaskets and bolts.

See also **technical information**

Material:

- S235JRG2

Surface treatment:

- Heat resistant paint

