

PIPECON

Exhaust gas silencer

Absorptive

ABS 25

Stock no. 00100

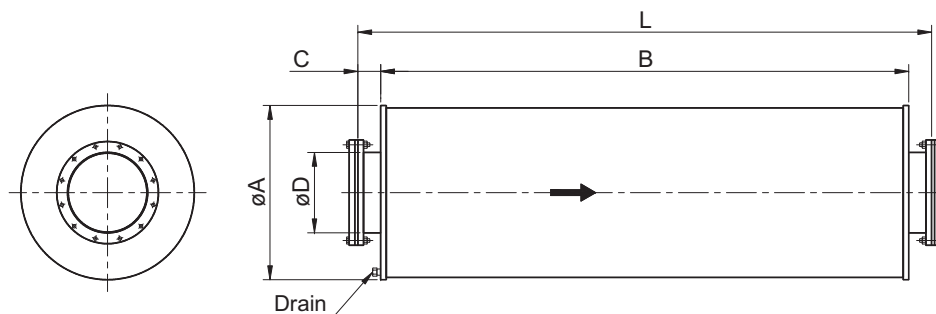

Stock No.	ND	øD [mm]	øA [mm]	B [mm]	L [mm]	C [mm]	Approx. Weight [kg]	Flange dimensions					
								Outer dia [mm]	Inner dia [mm]	PCD [mm]	Bolts NxMxL	T [mm]	Flange standard
00100-01-0065	65	76,1	285	900	1060	80	37	185	77	145	4-M16x40	10	DIN 2576
00100-01-0080	80	88,9	285	950	1110	80	38	200	90	160	8-M16x40	10	DIN 2576
00100-01-0100	100	114,3	335	1100	1260	80	52	220	115,5	180	8-M16x40	10	DIN 2576
00100-01-0125	125	139,7	365	1200	1360	80	65	250	141,5	210	8-M16x40	10	DIN 2576
00100-01-0150	150	168,3	365	1300	1460	80	74	285	170,5	240	8-M20x45	10	DIN 2576
00100-01-0175	175	193,7	415	1425	1585	80	100	315	196	270	8-M20x45	10	DIN 2576
00100-01-0200	200	219,1	415	1500	1700	100	105	340	221,5	295	8-M20x45	10	DIN 2576
00100-01-0250	250	273,0	570	1850	2050	100	180	375	276	335	12-M16x50	16	DIN 86044
00100-01-0300	300	323,9	670	2200	2400	100	250	440	327	395	12-M20x60	16	DIN 86044

Description:

Silencer is delivered with flanges, mating flanges, gaskets and bolts.

See also **technical information**

Material:

- S235JRG2

Surface treatment:

- Heat resistant paint

